

P A S T O E

VISION

design
pierre mazairac
karel boonzaaijer

1985

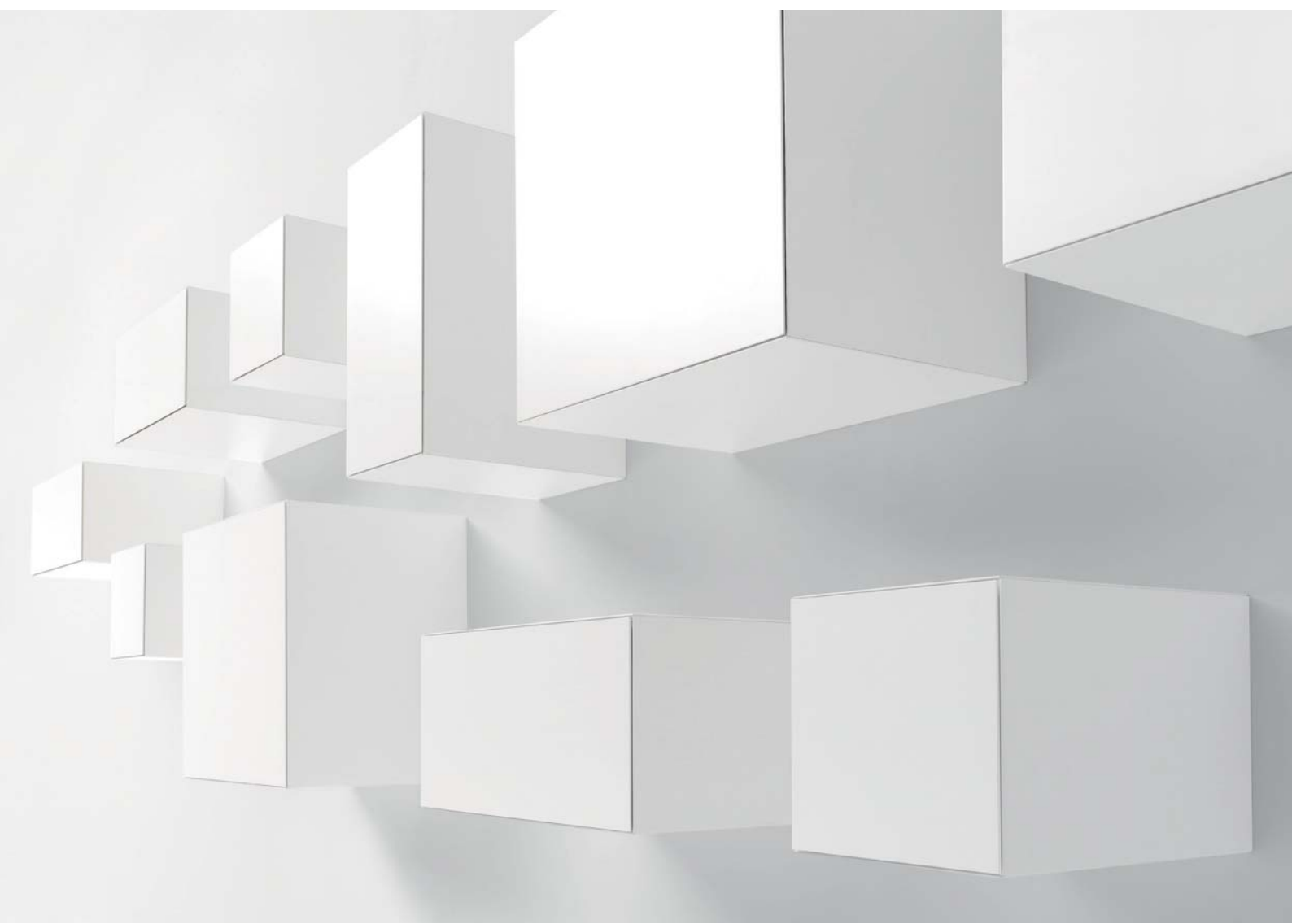

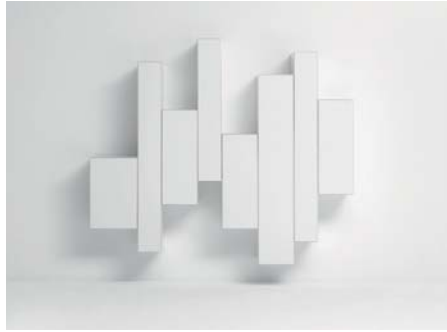
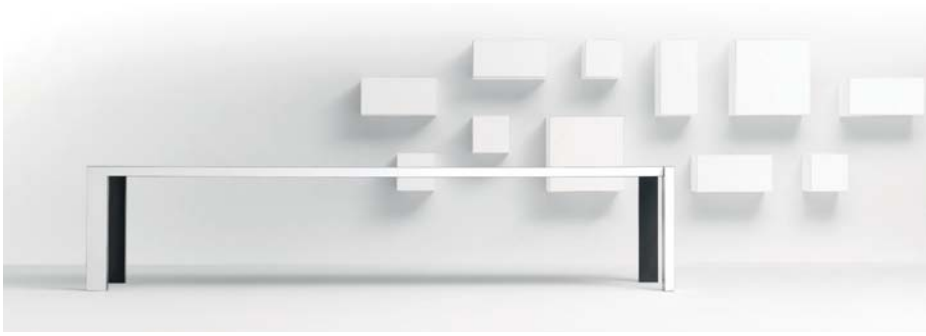

VISION

Vision is ontworpen vanuit de filosofie om een kast als compositie deel van de architectuur te laten zijn. Het uitgangspunt van Vision is één greeploze kubus in volledig verstek in verschillende diepte, hoogte en breedte. Fronten sluiten door middel van een druksysteem. Met slechts één vorm kan eindeloos worden gevarieerd in volume, kleur en lijnenspel. De mogelijkheden in compositie zijn onbeperkt; van een serie sideboards tot een architectonisch landschap van volumes, van object aan de wand tot onderdeel van de wand.

Vision was designed from the philosophy that a cabinet composition should be part of the total room architecture. The basis of Vision is a single cube without handles, completely mitred, and in different depths, heights and widths. Fronts close using a push-touch system. A single form yields endless variations of volume, colour and line composition. The possibilities for compositions are unlimited; from a series of sideboards to an architectonic landscape of volumes, from wall-mounted object to wall component.

P A S T O E

pastoe rotsoord 3
po box 2152
3500 gd utrecht
the netherlands
www.pastoe.com

VISION

design
pierre mazairac & karel boonzaaijer

1985

prijslijst
geldig vanaf maart 2012

liste des prix
valable à partir de mars 2012

listino prezzi
validità da marzo 2012

pricelist
valid from march 2012

preisliste
gültig ab März 2012

VISION

design

pierre mazairac & karel boonzaaijer

valid from march 2012

<p>Opbouw Kastensysteem bestaande uit rompen, (constructie)planken, deuren, laden, kleppen, planken aan de wand, frames en plinten. De fronten zijn greeploos en openen middels een druksysteem (snapper). De rompen kunnen worden geplaatst op metalen frames, wielen, plinten of hangend aan de wand. De rompen worden gestapeld, gekoppeld of vrijstaand toegepast.</p> <p>Afwerking</p> <p>Rompen : basis-/ glanslak, fineer (excl. achterpaneel en constructieplank) Interieur : basislak Fronten : basis-/ glanslak, fineer Ladebakken : eiken (standaard), basislak zwart 301 (meerprijs €50,- per ladebak) Interieurbakken : eiken (standaard), basislak zwart 301 (meerprijs €30,- per interieurbak) Frames : zilvergrijs gelakt metaal (RAL 9006) of basislak Plinten : basis-/ glanslak Plank aan de wand : basis-/ glanslak, fineer</p>	<p>Op aanvraag</p> <ul style="list-style-type: none">Ral / Sikkens kleurenMatlak afwerkingAfwijkende frontenindelingIn overleg kan het meubel in afwijkende maten gemaakt worden. Hiervoor geldt een afname van minimaal 25 stuks. <p>Algemeen De ladebakken worden voorzien van dubbel uittrekbare ladelopers met synchroon besturing en openen middels een druksysteem. In de "gloss" combinatie prijzen zijn alle onderdelen die in glanslak mogelijk zijn als glanslak berekend. Indien men één zijde in een andere kleur dan de romp kiest, geeft dit geen meerprijs. Dit geldt alleen voor de basic kleuren uit de Pastoe collectie. De prijzen staan vermeld in euro en zijn verkoopadviesprijzen. In Nederland en België inclusief btw, in overige landen exclusief btw. Wijzigingen en drukfouten zijn onder voorbehoud.</p>
<p>Composition Les armoires modulaires se composent de caissons, caisson ouvert sur deux côtés, rayons (de construction), portes, tiroirs, abattants, rayons muraux, pieds en métal et plinthe. Les caissons n'ont pas de poignée et s'ouvrent par un système à pression (snapper). Les caissons peuvent être montés sur des pieds, sur roulettes, sur plinthe ou d'accrocher au mur. Les caissons peuvent être montés superposés, couplés ou utilisés de façon autonome.</p> <p>Finition</p> <p>Caissons : laque en basique/ brillant, placage (sauf panneau arrière et rayon de construction) Intérieur : laque en basique Fronts : laque en basique/ brillant, placage Cassetiere : rovere (standard), lacca base nero 301 (sovrapprezzo per cassettone €50,-) Bacs intérieurs : chêne (standard), laqué noir 301 (supplément par bac intérieur €30,-) Pieds en métal : métal laqué gris argent (RAL 9006) ou laque en basique Plinthe : laque en basique/ brillant Rayon mural : laque en basique/ brillant, placage</p>	<p>Sur demande</p> <ul style="list-style-type: none">couleurs Ral / Sikkensle vernis de finition matRépartition frontale différenteLe meuble peut être fabriqué dans des dimensions différents, sur demande. Dans ce cas, une commande de 25 unités sera requise. <p>Informations générales Les blocs tiroirs en chêne sont munis de glissières double course avec commande synchronisée et s'ouvrent par un système à pression. Dans les prix des combinaisons "brillant" tous les éléments pouvant être en laque brillante ont été calculés comme tel. Aucun supplément n'est facturé si l'on désire un côté d'une couleur différente du caisson. Ceci est valable uniquement pour les couleurs de base de la collection Pastoe. Les prix sont indiqués en euros à titre indicatif. Pour les Pays-Bas et la Belgique, les prix sont calculés avec TVA, pour les autres pays, ils sont calculés hors taxe. Sous réserve de modifications et erreurs d'impression.</p>
<p>Composizione Il sistema di elementi componibili è costituito da scocche, ripiani (fissi), ante, cassetti, ribalte, mensole a parete e telai in metallo. Tutti i pannelli frontali sono privi di maniglie e si aprono mediante un sistema a pressione (snapper). Gli elementi possono essere posizionati su telai in metallo, su rotelle, su zoccoli o possono essere montati a parete. Le scocche possono essere sovrapposte, collegate o utilizzate indipendentemente.</p> <p>Finitura</p> <p>Scocche : laccato standard/ lucido, impiallacciatura (escl. pannello posteriore e ripiano strutturale) Interni : laccato standard Frontali : laccato standard/ lucido, impiallacciatura Cassettiere : rovere (standard), lacca base nero 301 (sovrapprezzo per cassettone €50,-) Cassetoni interni : rovere (standard), lacca base nero 301 (sovrapprezzo per cassettone €30,-) Telai in metallo : grigio argento (RAL 9006) o laccato standard Zoccoli : laccato standard/ lucido Mensole a parete : laccato standard/ lucido, impiallacciatura</p>	<p>Su richiesta</p> <ul style="list-style-type: none">I colori Ral / SikkensI colori laccati opachidiversa disposizione della parte frontaleSu richiesta il mobile può essere realizzato in altre misure, per ordini minimi di 25 pezzi. <p>Generale I cassettoni vengono dotate di doppie guide estraibili con sincronizzatore ed apertura mediante sistema a pressione. Nei prezzi delle combinazioni "gloss" tutte le parti disponibili in lucido sono indicate come lucido. Qualora si desideri un fianco in un colore diverso dalla scocca, ciò non determina alcun sovrapprezzo. Questo vale solo per i colori base della collezione Pastoe. I prezzi indicati sono in Euro e sono prezzi di vendita consigliati. Per l'Olanda ed il Belgio sono da considerarsi IVA inclusa, per gli altri paesi IVA esclusa. Con riserva di modifiche o errori di stampa.</p>
<p>Set-up The cabinet system consists of modules, (fixed) shelves, doors, drawers, flaps, shelf on the wall, frames, plinths. The fronts have no grips and open using a pressure system (snapper). The modules can be placed on frames, casters, plinths or can be hung on the wall. The bodies are stacked, connected or used independently.</p> <p>Finishing</p> <p>Modules : basic/ gloss lacquer, veneer (except on back panel and fixed shelf) Interior : basic lacquer Fronts : basic/ gloss lacquer, veneer Drawer bodies : oak (standard), basic lacquer black 301 (supplement payable for each drawer body €50,-) Interior compartment : oak (standard), basic lacquer black 301 (supplement payable for each interior compartment €30,-) Frames : silver grey metal (RAL 9006) or basic lacquer Plinths : basic/ gloss lacquer Shelf on the wal : basic/ gloss lacquer, veneer</p>	<p>On request</p> <ul style="list-style-type: none">Ral / Sikkens coloursmat lacquer finishAlternative front layoutIn consultation, this item can be produced in different sizes. This requires a minimum purchase of 25 units. <p>General Our drawers are fitted with double pull-out drawer runners with synchronous controls and a push-to-open system. In the "gloss" combination prices all parts available in gloss lacquer are priced as gloss lacquer. Should you want one side in a different colour from the body, that will not incur extra costs. This provision only applies to the basic colours from the Pastoe collection. These prices are given in euros and are recommended retail prices. They are inclusive of VAT (BTW) for the Netherlands and Belgium, exclusive of VAT for other countries. Subject to changes and printing errors.</p>
<p>Aufsatz Das Schranksystem besteht aus Korpus, an zwei Seiten offenen Korpus, (Konstruktions) boden, Türen, Schubladen, Klappen, Wandboard, Rahmen, Sockelleisten, gekreuzter Sockel und media-Korpus. Die Fronten haben keine Griffe und werden mit Hilfe eines Drucksystems (Schnapper) geöffnet. Die Korpusse können auf Rahmen, Rollen, Sockelleisten gestelltd werden oder an der Wand befestigt werden. Die Korpusse werden gestapelt, gekoppelt oder frei stehend zusammengestellt.</p> <p>Verarbeitung</p> <p>Korpusse : Basis-/ Glanzlack, Furnier (ohne Rückwand und Konstruktionsbrett) Interieur : Basislack Fronten : Basis-/ Glanzlack, Furnier Schubkasten : Eiche (Standardausführung), Basislack Schwarz 301 (€50,- Aufpreis pro Schubkasten) Interieürkasten : Eiche (Standardausführung), Basislack Schwarz 301 (€30,- Aufpreis pro Interieürkast) Rahmen : silbergrauem, lackierten Metall (RAL 9006) oder Basislack Sockelleisten : Basis-/ Glanzlack Wandboard : Basis-/ Glanzlack, Furnier</p>	<p>Auf Anfrage</p> <ul style="list-style-type: none">RAL / Sikkens FarbenMattlackAbweichende FrontenteilungNach Rücksprache kann das Möbel in abweichenden Maßen hergestellt werden. Dafür gilt ein Mindestabnahme von 25 Stück. <p>Allgemeines Die Kästen sind mit einer doppelt ausziehbaren Schubladenschiene mit Synchronsteuerung ausgestattet und können mit einem Drucksystem geöffnet werden. Bei den "gloss" Kombinationspreisen wurden alle Teile, die in Glanzlackausführung möglich sind, als Glanzlack berechnet. Für eine Seite in einer anderen Farbe als die des Korpus braucht man keinen Aufpreis zu bezahlen. Dies gilt ausschließlich für die Basic-Farben der Pastoe-Kollektion. Die Preise verstehen sich in Euro und sind unverbindliche Preisempfehlungen. In den Niederlanden und Belgien zuzüglich MwSt., in den übrigen Ländern ohne MwSt. Änderungen und Druckfehler vorbehalten.</p>

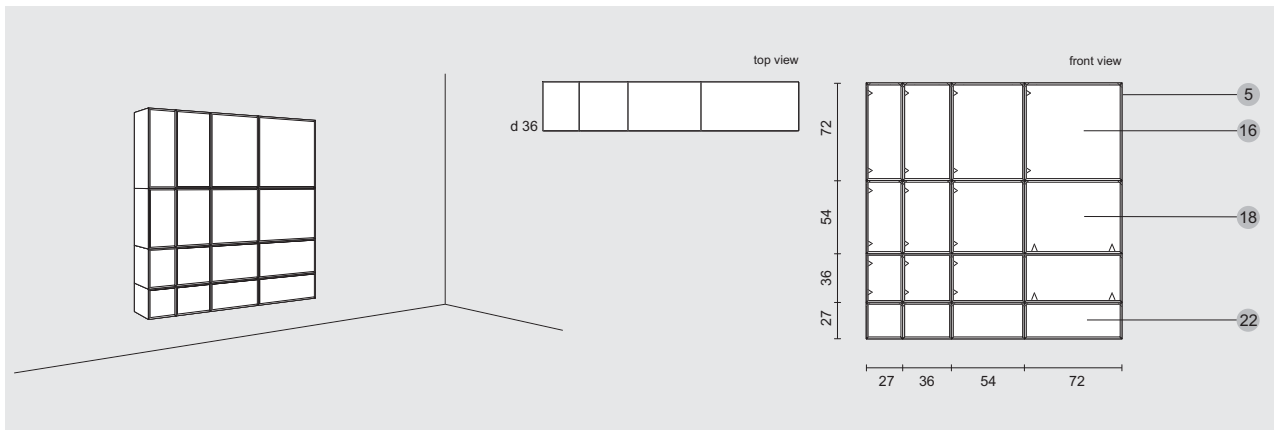

5. romp h72
16. deur
18. klep
22. laden

5. caisson h72
16. porte
18. abattant
22. tiroir

5. scocca h72
16. anta
18. ribalta
22. cassetti

5. module h72
16. door
18. flap
22. drawer

5. Korpus h72
16. Tür
18. Klappe
22. Schubladen

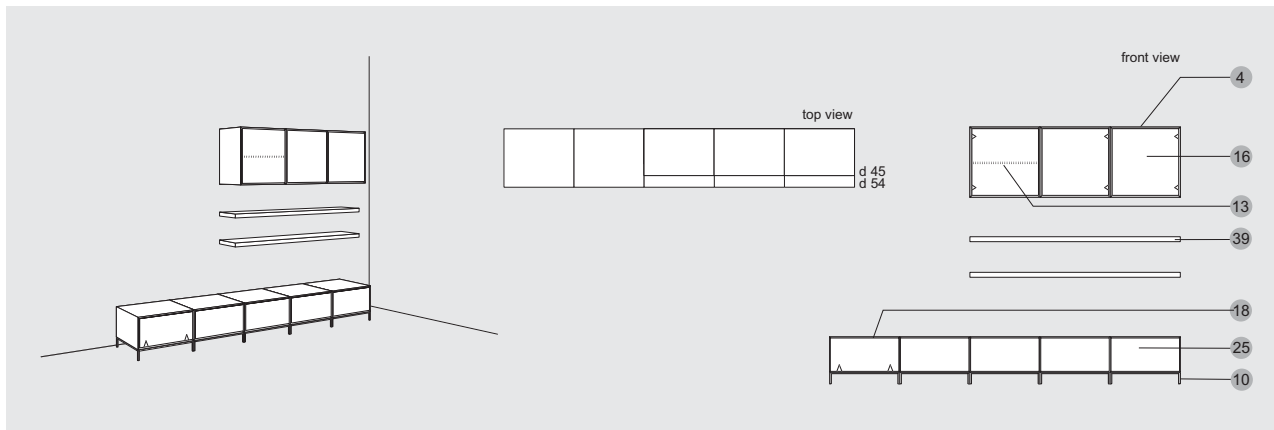

4. romp h54
10. metalen frame h9
13. legplank
16. deur
18. klep
25. lade
39. plank aan de wand

4. caisson h54
10. pied en métal h9
13. rayon
16. porte
18. abattant
25. tiroir
39. rayon mural

4. scocca h54
10. telaio in metallo h9
13. ripiano
16. anta
18. ribalta
25. cassetto
39. mensola a parete

4. module h54
10. metal frame h9
13. shelf
16. door
18. flap
25. drawer
39. shelf on the wall

4. Korpus h54
10. Metallrahmen h9
13. Einlegeboden
16. Tür
18. Klappe
25. Schubladen
39. Wandboard

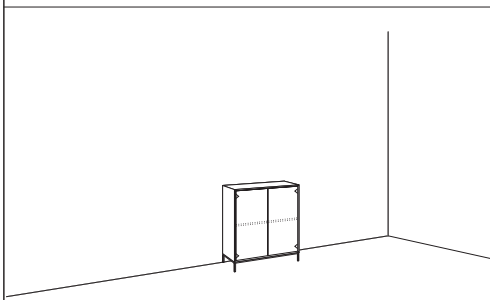

combination V360
price without finishing panel
h81 x w72 x d36

frame 9h in RAL 9006 lacquer
basic
gloss

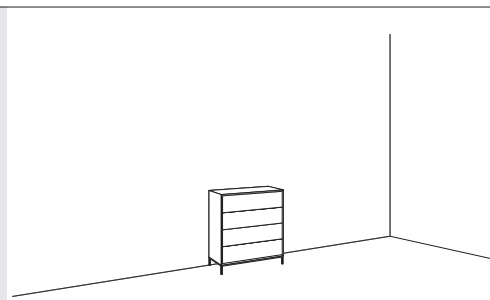

combination V362
price without finishing panel
h81 x w72 x d36

frame 9h in RAL 9006 lacquer
basic
gloss

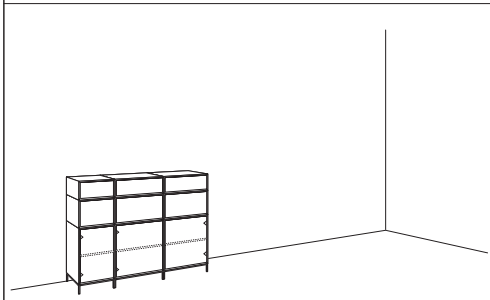

combination V364
h108 x w198 x d45

frame 9h in RAL 9006 lacquer
basic
gloss

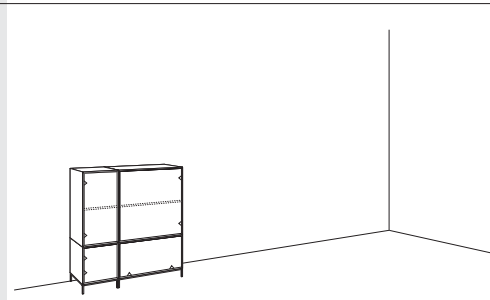

combination V365
h117 x w108 x d45









frame 9h in RAL 9006 lacquer
basic
gloss

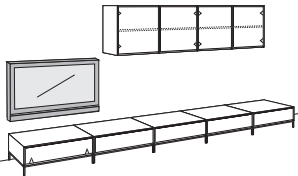
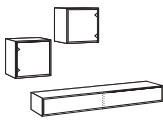

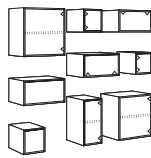

VISION

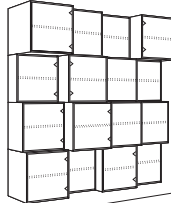
design

pierre mazairac & karel boonzaaijer

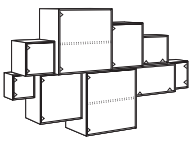
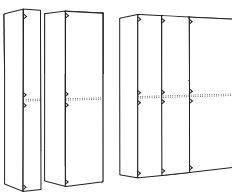
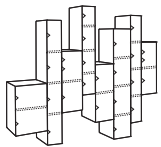
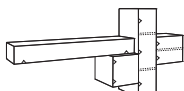
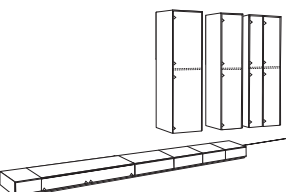
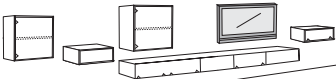
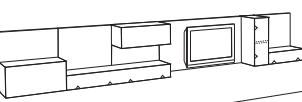
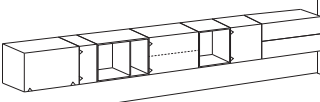
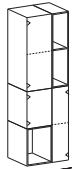
valid from march 2012

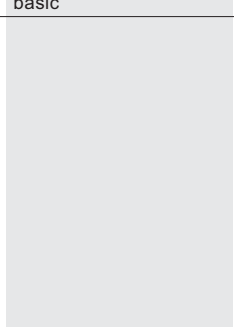
<p>combination V366 h216 x w54 x d45</p> <p>frame 9h in RAL 9006 lacquer basic gloss</p>		<p>combination V367 h27 x w360 x d54 h54 x w216 x d36</p> <p>frame 9h in RAL 9006 lacquer basic gloss</p>	
<p>Vision/ Vision Elements</p> <p>combination V262 h18 x w144 x d36 h36 x w36 x d36</p> <p>basic gloss</p>		<p>combination V385 h90 x w90 x d36</p> <p>basic gloss</p>	
<p>combination V337 h18 x w72 x d45</p> <p>basic gloss</p>		<p>combination V338 h54 x w54 x d36 h36 x w54 x d36 h18 x w54 x d36</p> <p>basic gloss</p>	
<p>combination V341 h108 x w216 x d22.5/36/45/54</p> <p>basic gloss</p>		<p>combination V339 2x h54 x w54 x d36 3x h27 x w27 x d36 4x h27 x w54 x d36</p> <p>basic gloss</p>	
<p>combination V336 h167 x w162 x d54</p> <p>basic gloss</p>		<p>combination V281 h216 x w216 x d22.5/36/45/54</p> <p>basic gloss</p>	
<p>combination V343 h72 x w36/54/72 x d36 h54 x w36/54/72 x d36 h36 x w36/54/72 x d36</p> <p>basic gloss</p>		<p>Vision/ Vision Elements</p> <p>combination V342 h36 x w36/54/72/108 x d36 h22.5 x w36/54/72/108 x d36 h18 x w36/54/72/108 x d36</p> <p>basic gloss</p>	

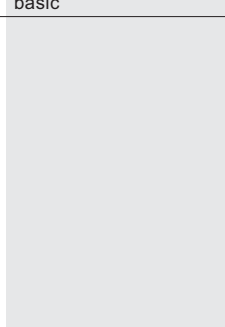
	<p>combination V335 h144 x w261 x d45</p> <p>basic gloss</p>		<p>combination V363 h108 x w18/54/27/36/72 x d36</p> <p>basic gloss</p>
	<p>combination V357 h180 x w189 x d36</p> <p>basic gloss</p>		<p>Vision/ Vision Elements</p> <p>combination V381 h108 x w225 x d45</p> <p>basic gloss</p>
	<p>Vision/ Vision Elements</p> <p>combination V368 h108 x w54/36/18/27 x d36 h22.5 x w36/108/54/54/36/36 x d54</p> <p>basic gloss</p>		<p>Vision/ Vision Elements</p> <p>combination V369 h36 x w54 x d22.5 h18 x w54 x d36 h54 x w54 x d36 h18 x w54 x d36 h18 x w270 x d45</p> <p>basic gloss</p>
	<p>Vision/ Vision Elements</p> <p>combination V380 h72 x w459 x d36</p> <p>basic gloss</p>		<p>Vision/Boxes</p> <p>combination V402 h36 x w324 x d36</p> <p>basic</p>
	<p>Vision/Boxes</p> <p>combination V403 h144 x w54 x d36</p> <p>basic</p>		<p>Vision/Boxes</p> <p>combination V404 h189 x w27 x d36</p> <p>basic</p>
			

VISION

design

pierre mazairac & karel boonzaaijer

valid from march 2012

		d 22.5				d 36				
1 <i>romp h18</i> caisson h18 scocca h18 module h18 Korpus h18		h x w	code	basic	gloss*	wood***	code	basic	gloss*	wood***
		18 x 27	V21114				V21110			
		18 x 36	V21124				V21120			
		18 x 54	V21134				V21130			
		18 x 72	V21144				V21140			
+ 60 euro										
2 <i>romp h27</i> caisson h27 scocca h27 module h27 Korpus h27		h x w	code	basic	gloss*	wood***	code	basic	gloss*	wood***
		27 x 18	V21004				V21000			
		27 x 27	V21014				V21010			
		27 x 36	V21024				V21020			
		27 x 54	V21034				V21030			
27 x 72	V21044				V21040					
+ 60 euro										
3 <i>romp h36</i> caisson h36 scocca h36 module h36 Korpus h36		h x w	code	basic	gloss*	wood***	code	basic	gloss*	wood***
		36 x 18	V21204				V21200			
		36 x 27	V21214				V21210			
		36 x 36	V21224				V21220			
		36 x 54	V21234				V21230			
36 x 72	V21244				V21240					
+ 60 euro										
4 <i>romp h54</i> caisson h54 scocca h54 module h54 Korpus h54		h x w	code	basic	gloss*	wood***	code	basic	gloss*	wood***
		54 x 18	V21304				V21300			
		54 x 27	V21314				V21310			
		54 x 36	V21324				V21320			
		54 x 54	V21334				V21330			
54 x 72	V21344				V21340					
+ 60 euro										
5 <i>romp h72</i> caisson h72 scocca h72 module h72 Korpus h72		h x w	code	basic	gloss*	wood***	code	basic	gloss*	wood***
		72 x 18	V21404				V21400			
		72 x 27	V21414				V21410			
		72 x 36	V21424				V21420			
		72 x 54	V21434				V21430			
72 x 72	V21444				V21440					
+ 60 euro										
6 <i>romp h108</i> caisson h108 scocca h108 module h108 Korpus h108		h x w	code	basic	gloss*	wood***	code	basic	gloss*	wood***
		108 x 18	V21604				V21600			
		108 x 27	V21614				V21610			
		108 x 36	V21624				V21620			
		108 x 54	V21634				V21630			
108 x 72	V21644				V21640					
+ 60 euro										

d 45			d 54								
code	basic	gloss* wood***	code	basic	gloss* wood***		h x w				
V21111			V21112				18 x 27	1 binnenmaten (cm) dimensions intérieures (cm) dimensioni interne (cm) inside measurements (cm) Innenmaßen (cm)			
V21121			V21122			18 x 36					
V21131			V21132			18 x 54					
V21141			V21142			18 x 72					
								height 18▶ 14.8	width 27▶ 23.8	depth 22.5▶ 17.8	
								36▶ 32.8	36▶ 31.3	45▶ 40.3	
								54▶ 50.8	45▶ 40.3	72▶ 68.8	
								72▶ 68.8	54▶ 49.3	49.3	
V21001			V21002				27 x 18	2 binnenmaten (cm) dimensions intérieures (cm) dimensioni interne (cm) inside measurements (cm) Innenmaßen (cm)			
V21011			V21012			27 x 27					
V21021			V21022			27 x 36					
V21031			V21032			27 x 54					
V21041			V21042			27 x 72		height 27▶ 23.8	width 18▶ 14.8	depth 22.5▶ 17.8	
								27▶ 23.8	36▶ 31.3	45▶ 40.3	
								36▶ 32.8	45▶ 40.3	72▶ 68.8	
								54▶ 50.8	54▶ 49.3	49.3	
V21201			V21202				36 x 18	3 binnenmaten (cm) dimensions intérieures (cm) dimensioni interne (cm) inside measurements (cm) Innenmaßen (cm)			
V21211			V21212			36 x 27					
V21221			V21222			36 x 36					
V21231			V21232			36 x 54					
V21241			V21242			36 x 72		height 36▶ 32.8	width 18▶ 14.8	depth 22.5▶ 17.8	
								27▶ 23.8	36▶ 31.3	45▶ 40.3	
								36▶ 32.8	45▶ 40.3	72▶ 68.8	
								54▶ 50.8	54▶ 49.3	49.3	
V21301			V21302				54 x 18	4 binnenmaten (cm) dimensions intérieures (cm) dimensioni interne (cm) inside measurements (cm) Innenmaßen (cm)			
V21311			V21312			54 x 27					
V21321			V21322			54 x 36					
V21331			V21332			54 x 54					
V21341			V21342			54 x 72		height 54▶ 50.8	width 18▶ 14.8	depth 22.5▶ 17.8	
								27▶ 23.8	36▶ 31.3	45▶ 40.3	
								36▶ 32.8	45▶ 40.3	72▶ 68.8	
								54▶ 50.8	54▶ 49.3	49.3	
V21401			V21402				72 x 18	5 binnenmaten (cm) dimensions intérieures (cm) dimensioni interne (cm) inside measurements (cm) Innenmaßen (cm)			
V21411			V21412			72 x 27					
V21421			V21422			72 x 36					
V21431			V21432			72 x 54					
V21441			V21442			72 x 72		height 72▶ 68.8	width 18▶ 14.8	depth 22.5▶ 17.8	
								27▶ 23.8	36▶ 31.3	45▶ 40.3	
								36▶ 32.8	45▶ 40.3	72▶ 68.8	
								54▶ 50.8	54▶ 49.3	49.3	
V21601			Rompen van 108 hoog kunnen alleen aan de wand worden bevestigd. In overleg kan 36d en 45d op plint of frame geplaatst worden. Bij zware belasting wordt aanbevolen een steunbuis toe te passen (pagina 10).				108 x 18	6 binnenmaten (cm) dimensions intérieures (cm) dimensioni interne (cm) inside measurements (cm) Innenmaßen (cm)			
V21611			Les caissons de 108 de hauteur peuvent uniquement être fixés au mur. 36d et 45d peuvent, en concertation, être posés sur une plinthe ou un pied. Pour supporter des objets lourds nous recommandons d'appliquer un tube-support (10).				108 x 27				
V21621			Le scocche alte 108 cm possono essere fissate unicamente alla parete. Su richiesta il 36d ed 45d possono essere montati su zoccolo o telaio. Per sostenere oggetti pesanti è consigliabile utilizzare un tubo di supporto (pagina 10).				108 x 36				
V21631			Bodies of 108 cm high can only be attached to the wall. In consultation, 36d and 45d can be placed on a plinth or frame. To support heavy products we recommend a support tube (page 10).				108 x 54				
V21641			108 cm hohe Korpusse können nur an der Wand befestigt werden. In Rücksprache kann 36d und 45d auf Sockelleiste oder Rahmen angebracht werden. Bei schwerer Belastung empfiehlt es sich ein Stützrohr anzuwenden (Seite 10).				108 x 72		height 108▶ 104.8	width 18▶ 14.8	depth 22.5▶ 17.8
								27▶ 23.8	36▶ 31.3	45▶ 40.3	
								36▶ 32.8	45▶ 40.3	72▶ 68.8	
								54▶ 50.8	54▶ 49.3	49.3	

* glanslak éénzijdig - laque en brillant simple face - lucido su un lato - gloss lacquer one-sided - Glanzlack einseitig

** glanslak tweezijdig - laque en brillant double face - lucido su due lati - gloss lacquer two-sided - Glanzlack zweiseitig

*** Zijden, blad en bodem in fineer, achterpaneel en constructieplank in basislak - Fianchi, piano e fondo in legno impiallacciato; pannello posteriore e ripiano strutturale laccati - Côtés, plateau et fond en placage bois, panneau arrière et rayon de construction laqués - Sides, panel and base in veneer; back panel and fixed shelf in basic lacquer - Seitenteile, Platte und Boden in Furnier; Rückwand und Konstruktionsboden in Basislack

VISION

design

pierre mazairac & karel boonzaaijer

valid from march 2012

		d 22.5				d 36			
7 romp h144 caisson h144 scocca h144 module h144 Korpus h144	h x w	code	basic	gloss*	wood***	code	basic	gloss*	wood***
	144 x 18	V21704				V21700			
	144 x 27	V21714				V21710			
	144 x 36	V21724				V21720			
	144 x 54	V21734				V21730			
	144 x 72	V21744				V21740			
8 ophanger ter bevestiging van romp aan wand suspension pour la fixation du caisson au mur gancio per il fissaggio a parete della scocca hanger to secure base to the wall Aufhänger zur Befestigung des Korpus an der Wand	set	code	metal			code	metal		
		V15799				V15799			
<p><i>Bij rompen van 108 en 144cm hoog dient u een dubbele ophangset te bestellen. Per kast dient u een set ophangers te bestellen.</i></p> <p><i>Pour les caissons de 108 et 144 cm de haut, vous devrez commander un double jeu de fixation. Vous devrez commander un jeu de suspensions par armoire.</i></p> <p><i>Per elementi con altezza 108 o 144 cm., è necessario un kit di sospensione doppio. Per ogni mobile dovete ordiare un set di supporti.</i></p> <p><i>For units where the body height is 108 or 144 cm, a double hanging set should be ordered. For each cabinet, you will need to order a set of hangers.</i></p> <p><i>Für Korpusse mit einer Höhe von 108 und 144 cm muss ein doppeltes Aufhänageset bestellt werden. Pro Schrank müssen Sie zusätzlich ein Set mit Aufhängehaken bestellen.</i></p>									
9 wielenset jeu de roulettes set di rotelle casters set Rollen									
<p><i>Bij het toepassen van wielen dient u ervoor te zorgen dat het grondvlak groot genoeg is i.v.m stabiliteit, let op bij laden en maak geen hoge opstellingen (maximaal 36 hoog).</i></p> <p><i>En cas d'utilisation de roulettes, veuillez, pour des raisons de stabilité, à ce que la surface de contact au sol soit suffisante (maximal 36 h). Faites attention en utilisant des tiroirs et évitez de faire des constructions hautes.</i></p> <p><i>In caso di applicazione di ruote assicurarsi che la base d'appoggio sia sufficientemente grande da garantire stabilità alla struttura (in altezza massimo 36 h). Valutare accuratamente l'inserimento nella struttura di eventuali cassetti e non comporre strutture troppo alte.</i></p> <p><i>When fitting wheels ensure the surface is large enough to provide adequate stability. Be careful when fitting drawers and do not build up too high (maximum 36 h).</i></p> <p><i>Bei der Benutzung von Rädern darauf achten, dass die Grundfläche hinsichtlich der Stabilität ausreichend groß ist (höchstens 36 hoch).</i></p>									

d 45

d 54

code basic gloss* wood***				h x w		7																		
V21701				144 x 18																				
V21711				144 x 27																				
V21721				144 x 36																				
V21731				144 x 54																				
V21741				144 x 72																				
		<p>Rompen van 144 hoog kunnen alleen aan de wand worden bevestigd. Bij zware belasting wordt aanbevolen een steunbuis toe te passen (pagina 10).</p> <p>Les caissons de 144 de hauteur peuvent uniquement être fixés au mur. Pour supporter des objets lourds nous recommandons d'appliquer un tube-support (10).</p> <p>Le scocche alte 144 cm possono essere fissate unicamente alla parete. Per sostenere oggetti pesanti è consigliabile utilizzare un tubo di supporto (pagina 10).</p> <p>Bodies of 144 cm high can only be attached to the wall. To support heavy products we recommend a support tube (page 10).</p> <p>144 cm hohe Korpusse können nur an der Wand befestigt werden. Bei schwerer Belastung empfiehlt es sich ein Stützrohr anzuwenden (Seite 10).</p>				<p>binnenmaten (cm) dimensions intérieures (cm) dimensioni interne (cm) inside measurements (cm) Innenmaßen (cm)</p> <table border="1"> <thead> <tr> <th>height</th> <th>width</th> <th>depth</th> </tr> </thead> <tbody> <tr> <td>144 ▶ 140.8</td> <td>18 ▶ 14.8</td> <td>22.5 ▶ 17.8</td> </tr> <tr> <td></td> <td>27 ▶ 23.8</td> <td>36 ▶ 31.3</td> </tr> <tr> <td></td> <td>36 ▶ 32.8</td> <td>45 ▶ 40.3</td> </tr> <tr> <td></td> <td>54 ▶ 50.8</td> <td>54 ▶ 49.3</td> </tr> <tr> <td></td> <td>72 ▶ 68.8</td> <td></td> </tr> </tbody> </table>	height	width	depth	144 ▶ 140.8	18 ▶ 14.8	22.5 ▶ 17.8		27 ▶ 23.8	36 ▶ 31.3		36 ▶ 32.8	45 ▶ 40.3		54 ▶ 50.8	54 ▶ 49.3		72 ▶ 68.8	
height	width	depth																						
144 ▶ 140.8	18 ▶ 14.8	22.5 ▶ 17.8																						
	27 ▶ 23.8	36 ▶ 31.3																						
	36 ▶ 32.8	45 ▶ 40.3																						
	54 ▶ 50.8	54 ▶ 49.3																						
	72 ▶ 68.8																							
code metal		code metal		set		8																		
V15799		V15799																						
code black		code black				9																		
V25011		V25011																						
V25012		V25012																						

* glanslak éénzijdig - laque en brillant simple face - lucido su un lato - gloss lacquer one-sided - Glanzlack einseitig

** glanslak tweezijdig - laque en brillant double face - lucido su due lati - gloss lacquer two-sided - Glanzlack zweiseitig

*** Zijden, blad en bodem in fineer; achterpaneel en constructieplank in basislak - Fianchi, piano e fondo in legno impiallacciato; pannello posteriore e ripiano strutturale laccati - Côtés, plateau et fond en placage bois, panneau arrière et rayon de construction laqués - Sides, panel and base in veneer; back panel and fixed shelf in basic lacquer - Seitentelle, Platte und Boden in Furnier; Rückwand und Konstruktionsboden in Basislack

VISION

design

pierre mazairac & karel boonzaaijer

valid from march 2012

10 metalen frame h9

pied en metal h9
telaio in metallo h9
metal frame h9
Metallrahmen h9

h x w

9 x 27

9 x 36

9 x 54

9 x 72

code silver grey basic

V24610,-

V24620,-

V24630,-

V24640,-

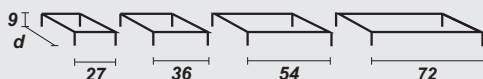

Rompen zijn niet naast elkaar op één frame te plaatsen. Rompen van 36d met laden kunnen niet op frame worden geplaatst. Tegen meerprijs verkrijgbaar in afwijkende hoogtematen tot max. 18h (€100,-).

Les caissons ne peuvent pas être posés les uns à côté des autres sur un seul cadre. Les caissons de 36d avec tiroirs être posés non sur un pied. Disponible en hauteurs différentes jusqu'à 18 cm de haut max. moyennant un supplément (€100,-).

Le scocche non possono essere piazzate una accanto all'altra su un unico telaio. Le scocche 36d con cassetto non possono essere montati su telaio. Disponibile in diverse altezze, fino a max 18h, dietro pagamento di supplemento (€100,-).

Bodies cannot be placed adjacent to each other on one frame. Bodies of 36d with a drawers cannot be place don a frame. Available in different heights up to 18cm for an additional charge (€100,-).

Korpuse sind nicht nebeneinander auf einen Rahmen zu platzieren. 36d Korpuse mit Schubladen können nicht auf Rahmen angebracht werden. Gegen einen Aufpreis in abweichenden Höhen bis max. 18 cm hoch erhältlich (€100,-).

11 eindplint

plinthe d'extrémité
zoccolo terminale
end plinth
Endsockelleiste

w

27

36

54

72

code basic gloss*

V24910

V24920

V24930

V24940

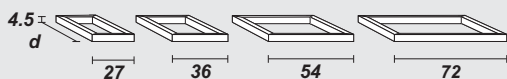

in hoogte verstelbaar
hauteur réglable
regolabile in altezza
adjustable height
In höhe verstellbar

De eindplint is altijd 90 mm smaller dan de romp. Deze plint kan op drie manieren onder een romp worden geplaatst. Tegen meerprijs verkrijgbaar in afwijkende hoogtematen (€100,-).

La plinthe d'extrémité fait toujours 90 mm de moins que la largeur du caisson. Cette plinthe peut être fixée sous un caisson de trois façons. Disponible en hauteurs différentes moyennant un supplément (€100,-).

Lo zoccolo terminale è 90 mm più stretto della scocca. Tale zoccolo può essere posizionato in tre diversi modi sotto la scocca. Disponibile in diverse altezze dietro pagamento di supplemento (€100,-).

The end plinth is always 90 mm narrower than the body. This plinth can be attached under a body in three ways. Available in different heights for an additional charge (€100,-).

Die Sockelleiste ist immer 90 mm schmaler als der Korpus. Es gibt drei Möglichkeiten, die Sockelleiste unter den Korpus anzubringen. Gegen einen Aufpreis in abweichenden Höhen erhältlich (€100,-).

12 middenplint

plinthe centrale
zoccolo intermedio
middle plinth
Mittelsockelleiste

w

27

36

54

72

code basic gloss*

V24010

V24020

V24030

V24040

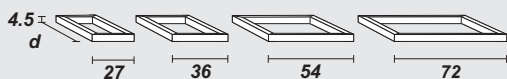

in hoogte verstelbaar
hauteur réglable
regolabile in altezza
adjustable height
In höhe verstellbar



De middenplint is gelijk aan de breedte van de romp. De plinten liggen aan de voorzijde 90 mm terug ten opzichte van de romp. Aan de achterzijde liggen plint en romp gelijk. Tegen meerprijs verkrijgbaar in afwijkende hoogtematen (€100,-).

La plinthe médiane a la même largeur que le caisson. En façade, les plinthes sont de 90 mm en retrait par rapport au caisson. Au dos, la plinthe et le caisson sont au même niveau. Disponible en hauteurs différentes moyennant un supplément (€100,-).

Lo zoccolo centrale ha la stessa larghezza della scocca. Nella parte anteriore gli zoccoli sono arretrati di 90 mm rispetto alla scocca. Nella parte posteriore lo zoccolo e la scocca sono allineati. Disponibile in diverse altezze dietro pagamento di supplemento (€100,-).

The central plinth is equal to the width of the body. The plinths are at the front, 90 mm back from the body. On the back, plinth and body are equal. Available in different heights for an additional charge (€100,-).

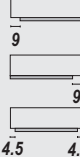
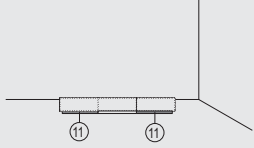
Die Breite der Mittelleiste entspricht der des Korpus. Im Verhältnis zum Korpus sind die Leisten an der Vorderseite 90 mm zurückgesetzt. An der Rückseite liegen Leiste und Korpus auf gleicher Höhe. Gegen einen Aufpreis in abweichenden Höhen erhältlich (€100,-).

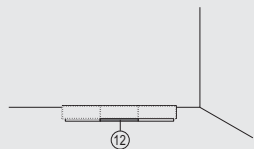
code silver grey basic			code silver grey basic			h x w		10
V24611			V24612			9 x 27		
V24621			V24622			9 x 36		
V24631			V24632			9 x 54		
V24641			V24642			9 x 72		
code basic gloss*			code basic gloss*			w		11
V24911			V24912			27		
V24921			V24922			36		
V24931			V24932			54		
V24941			V24942			72		
						sideview  9 frontview  9 4.5 4.5 		
code basic gloss*			code basic gloss*			w		12
V24011			V24012			27		
V24021			V24022			36		
V24031			V24032			54		
V24041			V24042			72		
						sideview  9 frontview  		

* glanslak éézijdig - laque en brillant simple face - lucido su un lato - gloss lacquer one-sided - Glanzlack einseitig
 ** glanslak tweezijdig - laque en brillant double face - lucido su due lati - gloss lacquer two-sided - Glanzlack zweiseitig

VISION

design

pierre mazairac & karel boonzaaijer

valid from march 2012

		d 22.5		d 36	
13 legplank rayon ripiano shelf Einlegeboden	w	code	basic	code	basic
	18	V23004		V23000	
	27	V23014		V23010	
	36	V23024		V23020	
	54	V23034		V23030	
	72	V23044		V23040	
14 constructieplank rayon de construction ripiano fisso fixed shelf Konstruktionboden	w				
	54				
	72				
		Bij zware belasting wordt aanbevolen een steunbuis toe te passen. Pour supporter des objets lourds nous recommandons d'appliquer un tube-support. Per sostenere oggetti pesanti è consigliabile utilizzare un tubo di supporto. To support heavy products we recommend a support tube. Bei schwerer Belastung empfiehlt es sich ein Stützrohr anzuwenden.			
15 steunbuis tube-support tubo di supporto support tube Stützrohr	w	code	silver grey		
	54	V25039	50,-		
	72	V25049	60,-		
16 deur porte anta door Tür	h x w	code	basic	gloss**	wood
	27 x 18	V22000			
	27 x 27	V22001			
	27 x 36	V22002			
	36 x 18	V22020			
	36 x 27	V22021			
	36 x 36	V22022			
	36 x 54	V22023			
	54 x 18	V22030			
	54 x 27	V22031			
	54 x 36	V22032			
	54 x 54	V22033			
	54 x 72	V22034			
	72 x 18	V22040			
	72 x 27	V22041			
	72 x 36	V22042			
	72 x 54	V22043			
	72 x 72	V22044			
	108 x 18	V22060			
	108 x 27	V22061			
	108 x 36	V22062			
108 x 54	V22063				
108 x 72	V22064				
144 x 18	V22070				
144 x 27	V22071				
144 x 36	V22072				
144 x 54	V22073				
144 x 72	V22074				

135°

d 45		d 54			
code	basic	code	basic	w	13
V23001		V23002		18	
V23011		V23012		27	
V23021		V23022		36	
V23031		V23032		54	
V23041		V23042		72	
		code	basic	w	14
		V23332		54	
		V23342		72	
				w	15
				54	
				72	
<p>Indien direct boven een 18 hoge lade een steunbuis wordt gemonteerd is het niet mogelijk een CD/DVD-interieur toe te passen.</p> <p>Si on utilise un tube-support juste au-dessus d'un tiroir de 18 de haut, on ne pourra pas placer d'intérieur CD/DVD.</p> <p>Il montaggio di un tubo di sostegno sopra un cassetto alto 18 non permette l'uso di un modulo interno porta CD/DVD.</p> <p>If a support tube is fitted directly above an 18cm high drawer, a CD/DVD interior can not be fitted.</p> <p>Wenn unmittelbar über einer 18 hohen Schublade ein Stützrohr montiert wird, kann kein CD/DVD-Interieur eingesetzt werden.</p>					
				h x w	16
				27 x 18	
				27 x 27	
				27 x 36	
				36 x 18	
				36 x 27	
				36 x 36	
				36 x 54	
				54 x 18	
				54 x 27	
				54 x 36	
				54 x 54	
				54 x 72	
				72 x 18	
				72 x 27	
				72 x 36	
				72 x 54	
				72 x 72	
				108 x 18	
				108 x 27	
				108 x 36	
				108 x 54	
				108 x 72	
				144 x 18	
				144 x 27	
				144 x 36	
				144 x 54	
				144 x 72	
					<p>De scharnier positie (links/rechts) en positie van de snapper (onder/boven) duidelijk op de order vermelden.</p> <p>Prrière d'indiquer clairement sur la commande la position de la charnière (gauche/droite) et la position du snapper (dessous/dessus).</p> <p>Indicare chiaramente sull'ordine la posizione del cardine (sinistra/destra) e la posizione dello snapper (in alto/in basso).</p> <p>When ordering, please state clearly the hinge position (left/right) and the position of the snapper (bottom/top).</p> <p>Die Scharnierposition (links/rechts) und die Position des Schnappers (unten/oben) deutlich auf der Bestellung angeben.</p>

VISION

design

pierre mazairac & karel boonzaaijer

valid from march 2012

17 deurenset jeu de portes set di ante set of doors Türensset		h x w 54 x 72	code basic gloss** wood V22434	
		72 x 72 V22444		



h 18	h 27
------	------

18 klep abattant ribalta flap Klappe		w 27	code basic gloss** wood V22291	code basic gloss** wood V22201
		36	V22292	V22202
		54	V22293	V22203
		72	V22294	V22204

19 media achterpanelen panneaux arrière pour appareils électriques pannelli posteriori centrali media back panels Media Rückpaneel		w 54	code basic V23113	code basic V23103
		72	V23114	V23104

20 afwerkpaneel panneau de finition pannello di finitura finishing panel Sichrückwand		w 27	code basic gloss** wood V22511	code basic gloss** wood V22501
		36	V22512	V22502
		54	V22513	V22503
		72	V22514	V22504

			h x w 54 x 72 72 x 72	17
--	--	--	------------------------------------	-----------

h 36	h 54	h 72
-------------	-------------	-------------

code	basic	gloss**	wood	code	basic	gloss**	wood	w	18 <i>De scharnier positie (onder/ boven) duidelijk op de order vermelden.</i> <i>Prière d'indiquer clairement sur la commande la position de la charnière (dessous/ dessus).</i> <i>Indicare chiaramente sull'ordine la posizione del cardine (in alto/in basso).</i> <i>When ordering, please state clearly the hinge position (top/bottom).</i> <i>Die Scharnierposition (unten / oben) deutlich auf der Bestellung angeben.</i>
V22221				V22231				27	
V22222				V22232				36	
V22223				V22233				54	
V22224				V22234				72	

code	basic	code	basic	w	19 <i>Media achterpaneel is voorzien van kabelgat en ventilatiegaten.</i> <i>Panneau arrière spécial pour le raccordement d'appareils pourvu d'un percement pour câbles et d'orifices d'aération.</i> <i>Pannello posteriore per media provvisto di fori per cavi e fori di areazione.</i> <i>Media back panel comes with holes for cables and for ventilation.</i> <i>Media Rückwand ist mit einem Kabeldurchlass und Belüftungsöffnungen versehen.</i>
V23123		V23133		54	
V23124		V23134		72	

code	basic	gloss**	wood	code	basic	gloss**	wood	code	basic	gloss**	wood	w	20 <i>Voor rompen die vrij in de ruimte komen te staan kan ter verfraaiing de achterzijde worden voorzien van een afwerkpaneel (optisch worden de voor- en achterzijde dan gelijk). Afwerkpanelen worden gemonteerd aan het "standaard" achterpaneel van de romp. Afwerkpanelen hebben altijd de afmeting van een volledige romp.</i> <i>Pour enjoliver l'arrière des caissons autonomes non fixés au mur, un panneau de finition peut être fixé à l'arrière (l'arrière et l'avant du caisson ont ainsi un aspect identique). Les panneaux de finition se fixent sur le panneau arrière "standard" du caisson. Les panneaux de finition ont toujours la dimension d'un caisson complet.</i> <i>Le scocche disposte liberamente nello spazio possono essere rifinite con un pannello posteriore (che rende visivamente uguali tra loro la parte posteriore e quella anteriore). I pannelli di rifinitura vengono montati sul pannello posteriore "di serie" della scocca. I pannelli di rifinitura hanno sempre la dimensione dell'intera scocca.</i> <i>For freestanding modules the rear side can be made more attractive by means of a finishing panel (ensuring both the front and the rear appear alike). Finishing panels are fitted to the standard rear panel on the module. The dimensions of the finishing panels are always the same as the complete body unit.</i> <i>Frei im Raum stehende Korpusse können auf der Rückseite zur Verschönerung mit einem Abschlusspaneel versehen werden (optisch sehen Vorder- und Rückseite dann gleich aus). Abschlusspaneele werden am „Standardrückpaneel“ des Korpus befestigt. Abschlusspaneele sind immer so groß wie ein vollständiger Korpus.</i>
V22521				V22531				V22541				27	
V22522				V22532				V22542				36	
V22523				V22533				V22543				54	
V22524				V22534				V22544				72	

* glanslak éénzijdig - laque en brillant simple face - lucido su un lato - gloss lacquer one-sided - Glanzlack einseitig
 ** glanslak tweezijdig - laque en brillant double face - lucido su due lati - gloss lacquer two-sided - Glanzlack zweiseitig







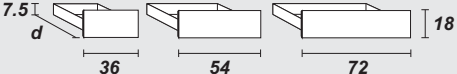

VISION

design

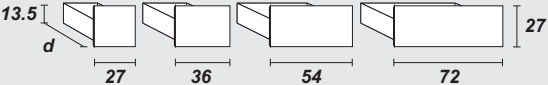
pierre mazairac & karel boonzaaijer

valid from march 2012

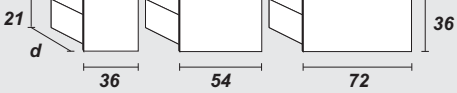
d 36

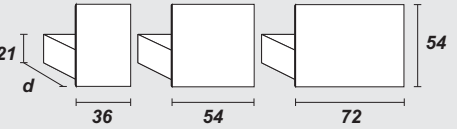
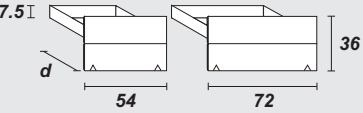
<p>21 laden 18h tiroirs 18h cassetti 18h drawers 18h Schublade 18h</p>  	<p>h x w</p> <p>18 x 36</p> <p>18 x 54</p> <p>18 x 72</p>		<p>code basic gloss** wood</p> <p>V27120</p> <p>V27130</p> <p>V27140</p>
<p>22 laden 27h tiroirs 27h cassetti 27h drawers 27h Schublade 27h</p>  	<p>h x w</p> <p>27 x 27</p> <p>27 x 36</p> <p>27 x 54</p> <p>27 x 72</p>		<p>code basic gloss** wood</p> <p>V27010</p> <p>V27020</p> <p>V27030</p> <p>V27040</p>
<p>23 laden 36h met een ladebak van 13.5h façade de tiroir de 36cm de hauteur avec tiroir de 13.5cm de hauteur. cassetti, altezza 36cm, con cassettoni interno alto 13.5cm drawers, height 36cm, with an inner drawer of 13.5cm 36cm hohe Schubladenfront mit 13.5cm hoher Schublade</p>  	<p>h x w</p> <p>36 x 36</p> <p>36 x 54</p> <p>36 x 72</p>		<p>code basic gloss** wood</p> <p>V27620</p> <p>V27630</p> <p>V27640</p>
<p>24 laden 36h met een ladebak van 21h façade de tiroir de 36cm de hauteur avec tiroir de 21cm de hauteur. cassetti, altezza 36cm, con cassettoni interno alto 21cm drawers, height 36cm, with an inner drawer of 21cm 36cm hohe Schubladenfront mit 21cm hoher Schublade</p>  	<p>h x w</p> <p>36 x 36</p> <p>36 x 54</p> <p>36 x 72</p>		<p>code basic gloss** wood</p> <p>V27720</p> <p>V27730</p> <p>V27740</p>
<p>25 laden 54h met een ladebak van 21h façade de tiroir de 54cm de hauteur avec tiroir de 21cm de hauteur. cassetti, altezza 54cm, con cassettoni interno alto 21cm drawers, height 54cm, with an inner drawer of 21cm 54cm hohe Schubladenfront mit 21cm hoher Schublade</p>  	<p>h x w</p> <p>54 x 36</p> <p>54 x 54</p> <p>54 x 72</p>		<p>code basic gloss** wood</p> <p>V29820</p> <p>V29830</p> <p>V29840</p>
<p>26 lade en klep 36h (2x18h) tiroir et abattant 36h (2x18h) cassetto e ribalta 36h (2x18h) drawer and flap 36h (2x18h) Schublade und Klappe 36h (2x18h)</p> 	<p>h x w</p> <p>36 x 54</p> <p>36 x 72</p>		<p>code basic gloss** wood</p> <p>V27530</p> <p>V27540</p>

d 45		d 54																								
code	basic gloss** wood	code	basic gloss** wood		h x w	21 binnenmaten (cm) dimensions intérieures (cm) dimensioni interne (cm) inside measurements (cm) Innenmaßen (cm)																				
V27121		V27121			18 x 36																					
V27131		V27131			18 x 54																					
V27141		V27141			18 x 72																					
						<table border="0"> <tr> <td></td> <td>height</td> <td>width</td> <td>depth</td> </tr> <tr> <td></td> <td>18▶ 11.5</td> <td>36▶ 28.4</td> <td>36▶ 26.4</td> </tr> <tr> <td></td> <td></td> <td>54▶ 46.4</td> <td>45▶ 36.4</td> </tr> <tr> <td></td> <td></td> <td>72▶ 64.4</td> <td>54▶ 36.4</td> </tr> </table>		height	width	depth		18▶ 11.5	36▶ 28.4	36▶ 26.4			54▶ 46.4	45▶ 36.4			72▶ 64.4	54▶ 36.4				
	height	width	depth																							
	18▶ 11.5	36▶ 28.4	36▶ 26.4																							
		54▶ 46.4	45▶ 36.4																							
		72▶ 64.4	54▶ 36.4																							
code	basic gloss** wood	code	basic gloss** wood		h x w	22 binnenmaten (cm) dimensions intérieures (cm) dimensioni interne (cm) inside measurements (cm) Innenmaßen (cm)																				
V27011		V27011			27 x 27																					
V27021		V27021			27 x 36																					
V27031		V27031			27 x 54																					
V27041		V27041			27 x 72	<table border="0"> <tr> <td></td> <td>height</td> <td>width</td> <td>depth</td> </tr> <tr> <td></td> <td>27▶ 20.5</td> <td>27▶ 19.4</td> <td>36▶ 26.4</td> </tr> <tr> <td></td> <td></td> <td>36▶ 28.4</td> <td>45▶ 36.4</td> </tr> <tr> <td></td> <td></td> <td>54▶ 46.4</td> <td>54▶ 36.4</td> </tr> <tr> <td></td> <td></td> <td>72▶ 64.4</td> <td></td> </tr> </table>		height	width	depth		27▶ 20.5	27▶ 19.4	36▶ 26.4			36▶ 28.4	45▶ 36.4			54▶ 46.4	54▶ 36.4			72▶ 64.4	
	height	width	depth																							
	27▶ 20.5	27▶ 19.4	36▶ 26.4																							
		36▶ 28.4	45▶ 36.4																							
		54▶ 46.4	54▶ 36.4																							
		72▶ 64.4																								
code	basic gloss** wood	code	basic gloss** wood		h x w	23 binnenmaten (cm) dimensions intérieures (cm) dimensioni interne (cm) inside measurements (cm) Innenmaßen (cm)																				
V27621		V27621			36 x 36																					
V27631		V27631			36 x 54																					
V27641		V27641			36 x 72																					
						<table border="0"> <tr> <td></td> <td>height</td> <td>width</td> <td>depth</td> </tr> <tr> <td></td> <td>36▶ 29.5</td> <td>36▶ 28.4</td> <td>36▶ 26.4</td> </tr> <tr> <td></td> <td></td> <td>54▶ 46.4</td> <td>45▶ 36.4</td> </tr> <tr> <td></td> <td></td> <td>72▶ 64.4</td> <td>54▶ 36.4</td> </tr> </table>		height	width	depth		36▶ 29.5	36▶ 28.4	36▶ 26.4			54▶ 46.4	45▶ 36.4			72▶ 64.4	54▶ 36.4				
	height	width	depth																							
	36▶ 29.5	36▶ 28.4	36▶ 26.4																							
		54▶ 46.4	45▶ 36.4																							
		72▶ 64.4	54▶ 36.4																							
code	basic gloss** wood	code	basic gloss** wood		h x w	24 binnenmaten (cm) dimensions intérieures (cm) dimensioni interne (cm) inside measurements (cm) Innenmaßen (cm)																				
V27721		V27721			36 x 36																					
V27731		V27731		Indien u een binnenlade besteld wordt de fadebak standaard 13,5 cm hoog. Si vous commandez un tiroir intérieur, la hauteur standard du tiroir sera de 13,5 cm. Se ordinate un cassetto interno, il cassetto diventa alto 13,5 cm. If you order an inner drawer, the drawer will be 13,5 cm high as standard. Wenn Sie eine Innenlade bestellen, hat die Schublade eine Standardhöhe von 13,5 cm.	36 x 54																					
V27741		V27741			36 x 72																					
						<table border="0"> <tr> <td></td> <td>height</td> <td>width</td> <td>depth</td> </tr> <tr> <td></td> <td>36▶ 29.5</td> <td>36▶ 28.4</td> <td>36▶ 26.4</td> </tr> <tr> <td></td> <td></td> <td>54▶ 46.4</td> <td>45▶ 36.4</td> </tr> <tr> <td></td> <td></td> <td>72▶ 64.4</td> <td>54▶ 36.4</td> </tr> </table>		height	width	depth		36▶ 29.5	36▶ 28.4	36▶ 26.4			54▶ 46.4	45▶ 36.4			72▶ 64.4	54▶ 36.4				
	height	width	depth																							
	36▶ 29.5	36▶ 28.4	36▶ 26.4																							
		54▶ 46.4	45▶ 36.4																							
		72▶ 64.4	54▶ 36.4																							
code	basic gloss** wood	code	basic gloss** wood		h x w	25 binnenmaten (cm) dimensions intérieures (cm) dimensioni interne (cm) inside measurements (cm) Innenmaßen (cm)																				
V29821		V29821			54 x 36																					
V29831		V29831			54 x 54																					
V29841		V29841			54 x 72																					
						<table border="0"> <tr> <td></td> <td>height</td> <td>width</td> <td>depth</td> </tr> <tr> <td></td> <td>54▶ 47.5</td> <td>36▶ 28.4</td> <td>36▶ 26.4</td> </tr> <tr> <td></td> <td></td> <td>54▶ 46.4</td> <td>45▶ 36.4</td> </tr> <tr> <td></td> <td></td> <td>72▶ 64.4</td> <td>54▶ 36.4</td> </tr> </table>		height	width	depth		54▶ 47.5	36▶ 28.4	36▶ 26.4			54▶ 46.4	45▶ 36.4			72▶ 64.4	54▶ 36.4				
	height	width	depth																							
	54▶ 47.5	36▶ 28.4	36▶ 26.4																							
		54▶ 46.4	45▶ 36.4																							
		72▶ 64.4	54▶ 36.4																							
code	basic gloss** wood	code	basic gloss** wood		h x w	26 binnenmaten (cm) dimensions intérieures (cm) dimensioni interne (cm) inside measurements (cm) Innenmaßen (cm)																				
V27531		V27531			36 x 54																					
V27541		V27541			36 x 72																					
						<table border="0"> <tr> <td></td> <td>height</td> <td>width</td> <td>depth</td> </tr> <tr> <td></td> <td>18▶ 12.7</td> <td>54▶ 46.4</td> <td>45▶ 36.4</td> </tr> <tr> <td></td> <td></td> <td>72▶ 64.4</td> <td>54▶ 36.4</td> </tr> </table>		height	width	depth		18▶ 12.7	54▶ 46.4	45▶ 36.4			72▶ 64.4	54▶ 36.4								
	height	width	depth																							
	18▶ 12.7	54▶ 46.4	45▶ 36.4																							
		72▶ 64.4	54▶ 36.4																							

* glanslak éénzijdig - laque en brillant simple face - lucido su un lato - gloss lacquer one-sided - Glanzlack einseitig
 ** glanslak tweezijdig - laque en brillant double face - lucido su due lati - gloss lacquer two-sided - Glanzlack zweiseitig

VISION

design

pierre mazairac & karel boonzaaijer

valid from march 2012

d 36

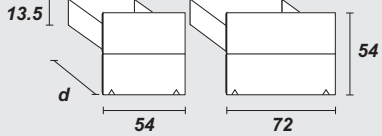
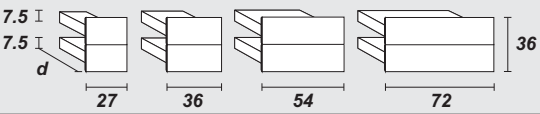
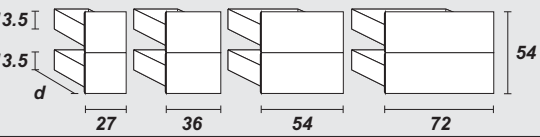
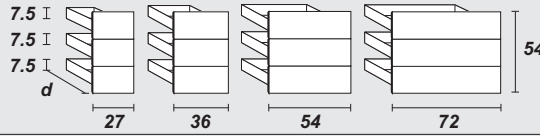
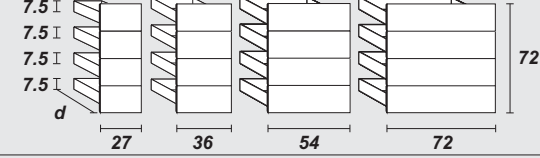
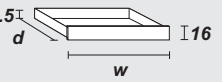
<p>27 <i>lade en klep 54h (2x27h)</i> tiroir et abattant 54h (2x27h) cassetto e ribalta 54h (2x27h) drawer and flap 54h (2x27h) Schublade und Klappe 54h (2x27h)</p> 	<p>h x w</p> <p>54 x 54</p> <p>54 x 72</p>		<p>code basic gloss** wood</p> <p>V29930</p> <p>V29940</p>
<p>28 <i>ladenset 36h (2x18h)</i> jeu de tiroirs 36h (2x18h) set di cassetti 36h (2x18h) set of drawers 36h (2x18h) Schubladenset 36h (2x18h)</p> 	<p>h x w</p> <p>36 x 27</p> <p>36 x 36</p> <p>36 x 54</p> <p>36 x 72</p>		<p>code basic gloss** wood</p> <p>V27210</p> <p>V27220</p> <p>V27230</p> <p>V27240</p>
<p>29 <i>ladenset 54h (2x27h)</i> jeu de tiroirs 54h (2x27h) set di cassetti 54h (2x27h) set of drawers 54h (2x27h) Schubladenset 54h (2x27h)</p> 	<p>h x w</p> <p>54 x 27</p> <p>54 x 36</p> <p>54 x 54</p> <p>54 x 72</p>		<p>code basic gloss** wood</p> <p>V27810</p> <p>V27820</p> <p>V27830</p> <p>V27840</p>
<p>30 <i>ladenset 54h (3x18h)</i> jeu de tiroirs 54h (3x18h) set di cassetti 54h (3x18h) set of drawers 54h (3x18h) Schubladenset 54h (3x18h)</p> 	<p>h x w</p> <p>54 x 27</p> <p>54 x 36</p> <p>54 x 54</p> <p>54 x 72</p>		<p>code basic gloss** wood</p> <p>V27310</p> <p>V27320</p> <p>V27330</p> <p>V27340</p>
<p>31 <i>ladenset 72h (4x18h)</i> jeu de tiroirs 72h (4x18h) set di cassetti 72h (4x18h) set of drawers 72h (4x18h) Schubladenset 72h (4x18h)</p> 	<p>h x w</p> <p>72 x 27</p> <p>72 x 36</p> <p>72 x 54</p> <p>72 x 72</p>		<p>code basic gloss** wood</p> <p>V27410</p> <p>V27420</p> <p>V27430</p> <p>V27440</p>
<p>32 <i>binnenlade, alleen in combinatie met een lade of klep van 36h</i> tiroir intérieur, seulement en combinaison avec un tiroir ou un abattant de 36 h cassetto interno solo in combinazione con un cassetto o una ribalta da 36h inner drawer, only in combination with a drawer or flap of 36 cm in height Innenschublade, Einsatz nur in Verbindung mit einer Schublade oder Klappe 36h</p> 	<p>w</p> <p>36</p> <p>54</p> <p>72</p>		<p>code basic gloss** wood</p> <p>V23220</p> <p>V23230</p> <p>V23240</p> <p><i>binnenlade van 36 diep</i> tiroir intérieur de 36 de profondeur cassetto interno profondo 36 inner drawer, depth 36 cm Innenschublade von 36 tief</p>

d 45		d 54							
code	basic	gloss**	wood	code	basic	gloss**	wood	h x w	27 <i>binnenmaten (cm)</i> dimensions intérieures (cm) dimensioni interne (cm) inside measurements (cm) Innenmaßen (cm)
V29931				V29931				36 x 54	
V29941				V29941				36 x 72	
									<i>height</i> 27 ▶ 21.7
									<i>width</i> 54 ▶ 46.4 45 ▶ 36.4 72 ▶ 64.4 54 ▶ 36.4
code	basic	gloss**	wood	code	basic	gloss**	wood	h x w	28 <i>binnenmaten (cm)</i> dimensions intérieures (cm) dimensioni interne (cm) inside measurements (cm) Innenmaßen (cm)
V27211				V27211				36 x 27	
V27221				V27221				36 x 36	
V27231				V27231				36 x 54	
V27241				V27241				36 x 72	
									<i>height</i> 36(2x18) ▶ min. 12.7
									<i>width</i> 27 ▶ 19.4 36 ▶ 26.4 36 ▶ 28.4 45 ▶ 36.4 54 ▶ 46.4 54 ▶ 36.4 72 ▶ 64.4
code	basic	gloss**	wood	code	basic	gloss**	wood	h x w	29 <i>binnenmaten (cm)</i> dimensions intérieures (cm) dimensioni interne (cm) inside measurements (cm) Innenmaßen (cm)
V27811				V27811				54 x 27	
V27821				V27821				54 x 36	
V27831				V27831				54 x 54	
V27841				V27841				54 x 72	
									<i>height</i> 54(2x27) ▶ min. 21.7
									<i>width</i> 27 ▶ 19.4 36 ▶ 26.4 36 ▶ 28.4 45 ▶ 36.4 54 ▶ 46.4 54 ▶ 36.4 72 ▶ 64.4
code	basic	gloss**	wood	code	basic	gloss**	wood	h x w	30 <i>binnenmaten (cm)</i> dimensions intérieures (cm) dimensioni interne (cm) inside measurements (cm) Innenmaßen (cm)
V27311				V27311				54 x 27	
V27321				V27321				54 x 36	
V27331				V27331				54 x 54	
V27341				V27341				54 x 72	
									<i>height</i> 54(3x18) ▶ min. 12.7
									<i>width</i> 27 ▶ 19.4 36 ▶ 26.4 36 ▶ 28.4 45 ▶ 36.4 54 ▶ 46.4 54 ▶ 36.4 72 ▶ 64.4
code	basic	gloss**	wood	code	basic	gloss**	wood	h x w	31 <i>binnenmaten (cm)</i> dimensions intérieures (cm) dimensioni interne (cm) inside measurements (cm) Innenmaßen (cm)
V27411				V27411				72 x 27	
V27421				V27421				72 x 36	
V27431				V27431				72 x 54	
V27441				V27441				72 x 72	
									<i>height</i> 72(4x18) ▶ min. 12.7
									<i>width</i> 27 ▶ 19.4 36 ▶ 26.4 36 ▶ 28.4 45 ▶ 36.4 54 ▶ 46.4 54 ▶ 36.4 72 ▶ 64.4
code	basic	gloss**	wood	code	basic	gloss**	wood	w	32 <i>binnenmaten (cm)</i> dimensions intérieures (cm) dimensioni interne (cm) inside measurements (cm) Innenmaßen (cm)
V23220				V23221				36	
V23230				V23231				54	
V23240				V23241				72	
<i>binnenlade van 36 diep</i> tiroir intérieur de 36 de profondeur cassetto interno profondo 36 inner drawer, depth 36 cm Innenschublade von 36 tief									<i>height</i> 16 ▶ 12.7
									<i>width</i> 36 ▶ 28.4 36 ▶ 26.4 54 ▶ 46.4 45 ▶ 36.4 72 ▶ 64.4

* glanslak éénzijdig - laque en brillant simple face - lucido su un lato - gloss lacquer one-sided - Glanzlack einseitig
 ** glanslak tweezijdig - laque en brillant double face - lucido su due lati - gloss lacquer two-sided - Glanzlack zweiseitig

VISION

design

pierre mazairac & karel boonzaaijer

valid from march 2012

d 22.5

d 36

33 binnenlade, alleen in combinatie met een lade of klep van 54h tiroir intérieur, seulement en combinaison avec un tiroir ou un abattant de 54 h cassetto interno solo in combinazione con un cassetto o una ribalta da 54h inner drawer, only in combination with a drawer or flap of 54 cm in height Innenschublade, Einsatz nur in Verbindung mit einer Schublade oder Klappe 54h	w		code	basic	gloss**	wood
	36		V23250			
	54		V23260			
	72		V23270			
			binnenlade van 36 diep tiroir intérieur de 36 de profondeur cassetto interno profondo 36 inner drawer, depth 36 cm Innenschublade von 36 tief			

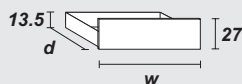

34 interieurbakken inzet bacs intérieurs à insérer cassettoni interni inseribili insert interior compartments Interieurbakken Einsatz		code	oak
	compartment 1	X59005	
binnenmaten (cm) dimensions intérieures (cm) dimensioni interne (cm) inside measurements (cm) Innenmaßen (cm)			
height 4.4 ▶ 3.5	width 25.0 ▶ 24.1	depth 9.8 ▶ 8.9	

35 interieurbakken basis bacs intérieurs de base standard cassettoni interni di base interior compartment Interieurbakken Basis		code	oak
	compartment 2	X59006	
	compartment 3	X59007	
	compartment 4	X59008	
binnenmaten (cm) dimensions intérieures (cm) dimensioni interne (cm) inside measurements (cm) Innenmaßen (cm)			
height 5.3 ▶ 4.4	width 26.2 ▶ 25.2	depth 36.2 ▶ 35.2 41.2 ▶ 40.2 46.2 ▶ 45.2	
			De basisbakken zijn te combineren met een aluminium schuifprofiel, waardoor de bakken verhoogd in de ladebak komen te liggen. Les bacs de base peuvent être combinés avec un profilé coulissant en aluminium qui permet de rehausser les bacs dans le tiroir. I cassettoni di base possono essere combinati con un profilo di scorrimento in alluminio, che li sospendono all'interno dei cassettoni. The standard compartments can be combined with an aluminium sliding track, allowing the compartments to be raised in high drawers. Die Basiskästen können mit Aluminium Schubprofilen kombiniert werden, sodass die Kästen erhöht im Schubladenkasten liegen.

d 45

d 54

code	basic	gloss**	wood	code	basic	gloss**	wood	w
V23250				V23251				36
V23260				V23261				54
V23270				V23271				72
<i>binnenlade van 36 diep</i>				<i>binnenlade van 45 diep</i>				
tiroir intérieur de 36 de profondeur				tiroir intérieur de 45 de profondeur				
cassetto interno profondo 36				cassetto interno profondo 45				
inner drawer, depth 36 cm				inner drawer, depth 45 cm				
Innenschublade von 36 tief				Innenschublade von 45 tief				

33

binnenmaten (cm)
 dimensions intérieures (cm)
 dimensioni interne (cm)
 inside measurements (cm)
 Innenmaßen (cm)

	height	width	depth
27 ▶	21.7	36 ▶ 28.4	36 ▶ 26.4
54 ▶		46.4	45 ▶ 36.4
72 ▶		64.4	

34

35

VISION

design
pierre mazairac & karel boonzaaijer
valid from march 2012

		d 36		d 45/54	
36 <i>schuifprofiel</i> profilé coulissant profilo di scorrimento sliding track Schubprofil	w	code	aluminium	code	aluminium
	54	X50730		X50730	
	72	X50740		X50740	

37 <i>CD/DVD interieur</i> intérieur CD/DVD interno porta CD/DVD CD/DVD interior CD/DVD Interieur	w	code	aluminium
	54	X80733	max. 45 CD
	54	X90732	max. 18 DVD
	72	X80743	max. 60 CD
	72	X90742	max. 27 DVD

38 <i>rubberen mat</i> tapis en caoutchouc stuoino in gomma rubber mat Gummimatte	w	code	rubber
	27	X70710	
	36	X70720	
	54	X70730	
	72	X70740	

<p><i>Het aluminium schuifprofiel loopt over de gehele breedte van de ladebak en is toe te passen in ladebakken van 13,5 en 21 cm hoog.</i></p> <p>Le profilé aluminium court sur toute la largeur du tiroir et peut être installé dans des tiroirs de 13,5 et 21 cm de haut.</p> <p>Il profilo di scorrimento in alluminio corre lungo tutta la larghezza del cassettone e può essere montato nei cassettoni alti 13,5 e 21 cm.</p> <p>The aluminium sliding track covers the width of the drawer and can be used in drawers of 13.5 and 21 cm high.</p> <p>Das Aluminium Schubprofil läuft über die gesamte Breite des Schubladenkastens und kann in 13,5 und 21 cm hohen Schubladenkästen verwendet werden.</p>				

code	aluminium	code	aluminium	w
X80734	max. 60 CD	X80734	max. 60 CD	54
X90733	max. 26 DVD	X90733	max. 26 DVD	54
X80744	max. 80 CD	X80744	max. 80 CD	72
X90743	max. 39 DVD	X90743	max. 39 DVD	72

Indien direct boven een binnenlade / 18 hoge lade een steunbuis wordt gemonteerd is het niet mogelijk een CD/DVD-interieur toe te passen. DVD interieur niet toe passen in 18 cm hoge laden.

Si on utilise un tube-support juste au-dessus d'un tiroir intérieur / tiroir de 18 de haut, on ne pourra pas placer d'intérieur CD/DVD. Il n'est pas possible de placer l'intérieur DVD dans des tiroirs de 18 cm de haut.

Il montaggio di un tubo di sostegno sopra un cassetto interno / cassetto alto 18 non permette l'uso di un modulo interno porta CD/DVD. Gli interni porta DVD non possono essere utilizzati con cassette di altezza 18 cm.

If a support tube is fitted directly above an inner drawer / 18cm high drawer, a CD/DVD interior cannot be fitted. DVD interiors cannot be used inside drawers with a height of 18 cm.

Wenn unmittelbar über einer Innenschublade 18 hohen Schublade ein Stützrohr montiert wird, kann kein CD/DVD-Interieur eingesetzt werden.

code	rubber	code	rubber	w
X70711		X70711		27
X70721		X70721		36
X70731		X70731		54
X70741		X70741		72

VISION

design

pierre mazairac & karel boonzaaijer

valid from march 2012

39 plank aan de wand

rayon mural

mensola a parete

wall shelf

Wandboard

w	code	basic	gloss**	wood
54.0-100.0	X10120			
100.1-150.0	X10130			
150.1-200.0	X10140			
200.1-279.0	X10150			

1m



d 22.5

d 36

h 18

h 27

40 wandpaneel

Panneau mural

Pannelo a parete

Wall panel

Wandpaneel

w	code	basic	gloss*	code	basic	gloss*
36	V51012			V51002		
54	V51013			V51003		
72	V51014			V51004		
108	V51016			V51006		
144	V51017			V51007		
162	V51018			V51008		

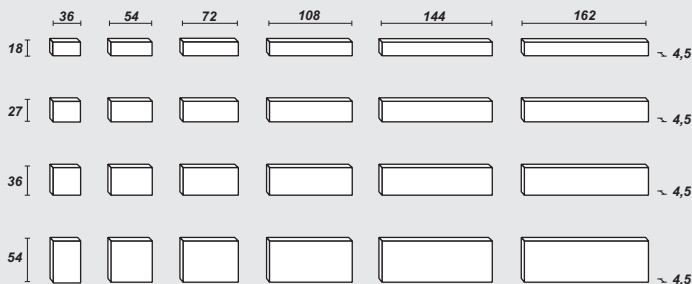

h 72

h 90

41 wandpaneel voor flatscreen

Panneau mural pour écran plat

Pannelo a parete per a schermo piatto

Wall panel for flatscreen

Wandpaneel für das Flatscreen

w	code	basic	gloss*	code	basic	gloss*
108	V51146			V51156		
144	V51147			V51157		
162	V51148			V51158		

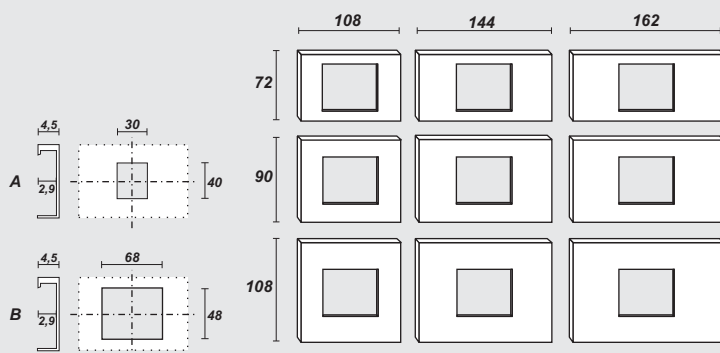

Pastoe raadt, voor de bevestiging van een flatscreen aan de muur, een beugel van Vogel aan, type 6345 of 6445 (tekening B). Keuze van de centrale uitsparing duidelijk vermelden op de order (A of B). Afwijkende maten van de uitsparing op aanvraag. Op aanvraag is het wandpaneel zonder uitsparing leverbaar.

Pour la fixation murale d'un écran plat, Pastoe conseille l'utilisation d'un support Vogel de type 6345 ou 6445 (dessin B). Prière d'indiquer clairement sur la commande l'encoche centrale choisie (A ou B). Autres dimensions de l'encoche disponibles sur demande. Pannau mural sans encoche disponible sur demande.

Per il fissaggio a parete dello schermo piatto, Pastoe consiglia l'impiego di un supporto di Vogel, tipo 6345 o 6445 (disegno B). Indicare chiaramente nell'ordine la scelta della tacca centrale (A o B). Tacche di misura diversa sono disponibili su richiesta. Su richiesta è possibile fornire un pannello a muro senza tacca.

For mounting flat screens to the wall, Pastoe recommends using Vogel brackets, types 6345 or 6445 (drawing B). Please mention your choice of central opening clearly on the order form (A or B). Other opening dimensions are available on request. Wall panels without openings are available on request.

Pastoe empfiehlt einen Bügel von Vogel, Typ 6345 oder 6445 (Zeichnung B), zur Befestigung eines Flachbildschirms an der Wand zu verwenden. Bitte die Wahl der zentralen Aussparung deutlich auf dem Bestellformular angeben (A oder B). Von der Aussparung abweichende Maße erhalten Sie auf Anfrage. Auf Wunsch ist das Wandpaneel auch ohne Aussparung erhältlich.

d 45

d 54

39

Plank aan de wand wordt op maat gemaakt binnen de aangegeven afmetingen. Montage aan de wand geschiedt middels een strip met pennen. Pastoe raadt voor de bevestiging van plank aan de wand een betonnen of stenen muur aan.

L'étagère au mur est taillée sur mesure à l'intérieur des dimensions indiquées. La fixation au mur est réalisée à l'aide d'une plaque avec des chevilles. Pour la fixation d'une étagère murale, Pastoe recommande un mur en béton ou en pierre.

Mensola a parete fornita su misura entro le dimensioni limite indicate. Il montaggio a parete avviene mediante una striscia dotata di perni. Pastoe consiglia di fissare le mensole a parete a pareti di cemento o pietra.

Shelf on the wall is measured individually within the dimensions indicated. Mounting on the wall is done with a strip containing pins. Pastoe recommends a concrete or stone wall as the base for shelf on the wall.

Wandboards werden auf maß innerhalb derausgegeben Größe gefertigt. Die Wandmontage erfolgt über ein Holzbrett mit Befestigungsstiften. Pastoe empfiehlt für die Befestigung des Brettes an der Wand eine Massivwand aus Beton oder Mauerwerk.

h 36

h 54

40

code	basic	gloss*	code	basic	gloss*	w
V51022			V51032			36
V51023			V51033			54
V51024			V51034			72
V51026			V51036			108
V51027			V51037			144
V51028			V51038			162

h 108

41

code	basic	gloss*	w
V51166			108
V51167			144
V51168			162

* glanslak éénzijdig - laque en brillant simple face - lucido su un lato - gloss lacquer one-sided - Glanzlack einseitig

** glanslak tweezijdig - laque en brillant double face - lucido su due lati - gloss lacquer two-sided - Glanzlack zweiseitig

VISION

design

pierre mazairac & karel boonzaaijer

valid from march 2012

42 kabeldoorvoer

Passe-câbles

Passacavo

Cable feedthrough

Kabelöffnung

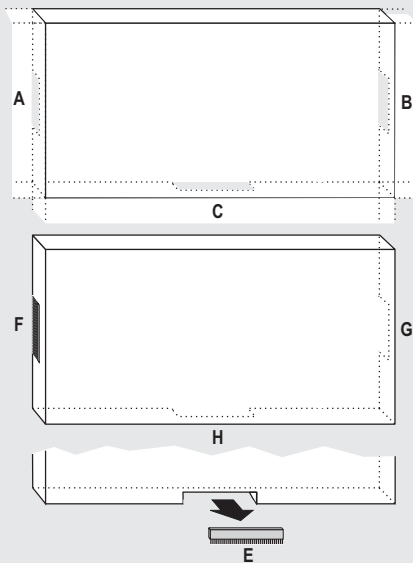
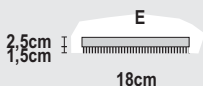
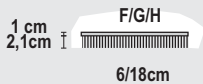
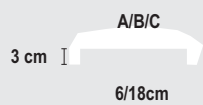

position	code	no profile	natural aluminium	basic
A	X10400			
B	X10410			
C	X10420			
E	X10340			
F	X10450			
G	X10460			
H	X10470			

43 kabeldoorvoer met aangepast achterpaneel

Passe-câbles avec panneau arrière adapté

Passacavo con pannello posteriore adeguati

Cable feedthrough with adapted back panel

Kabelöffnung mit angepasst Wandpaneel

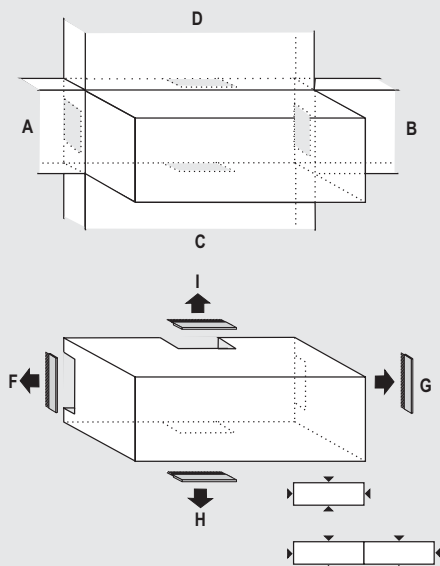
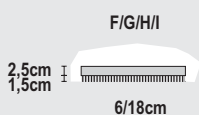
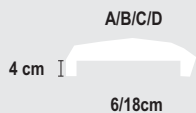

position	code	no profile	natural aluminium	basic
A	X10300			
B	X10310			
C	X10320			
D	X10330			
F	X10350			
G	X10360			
H	X10370			
I	X10380			

Op de bestelling dient aangegeven te worden of de kabeldoorvoer meer naar links of rechts, danwel meer naar onder of boven komt. Pastoe bepaalt de exacte positie aan de hand van een logisch raster. De afmeting van de kabeldoorvoer is standaard 18cm, alleen bij een paneel van 18 en 27cm is de kabeldoorvoer 6cm. Een kabeldoorvoer aan de rand van een paneel (A, B, C) is een uitsparing **zonder** aluminium profiel en zwarte borstel. Een kabeldoorvoer aan de rand van een paneel (F, G, H) is een uitsparing afgewerkt met een **vast** aluminium profiel met zwarte borstel. Een kabeldoorvoer aan de voorkant van een paneel (E) is een uitsparing afgewerkt met een **afneembaar** aluminium profiel met zwarte borstel.

Prière d'indiquer sur la commande si le passe-câbles doit être plutôt à gauche ou à droite, ou plutôt en haut ou en bas. Pastoe déterminera la position exacte d'après une grille logique. La dimension standard du passe-câbles est de 18 cm ; seulement avec les panneaux de 18 et 27 cm, le passe-câbles sera de 6 cm. Un passe-câbles placé sur le côté d'un panneau (A, B, C) est une encoche **sans** un profilé en aluminium **fixe** et une brosse noire. Un passe-câbles placé sur le côté d'un panneau (F, G, H) est une encoche comportant un profilé en aluminium fixe avec une brosse noire. Un passe-câbles placé sur le devant d'un panneau (E) est une encoche comportant un profilé en aluminium **détachable** avec une brosse noire.

Sull'ordine è necessario specificare se il passacavo è previsto più a sinistra o a destra, oppure più verso l'alto o verso il basso. Pastoe definisce la posizione sulla base di uno schema logico. La misura del passacavo è standard ed è pari a 18 cm; solo ai pannelli di 18 e 27 cm si applica un passacavo di 6 cm. Un passacavo al margine di un pannello (A, B, C) corrisponde ad una tacca rifinita **senza** un profilo di alluminio e spazzola nera. Un passacavo al margine di un pannello (F, G, H) corrisponde ad una tacca rifinita con un profilo di alluminio **fisso**, dotato di spazzola nera. Un passacavo nella parte anteriore di un pannello (E) corrisponde ad una tacca rifinita con un profilo di alluminio **amovibile**, dotato di spazzola nera.

The order form must clearly state whether the cable feedthrough should be located more towards the left or to the right, or more towards the top or the bottom. Pastoe will determine the exact position based on a logical grid. The width of the cable feedthrough is 18cm as standard, except for an 18 or 27cm panel, when the cable feedthrough is 6cm wide. A cable feedthrough on the edge of a panel (A, B, C) is an opening **without** a aluminium profile and black brush. A cable feedthrough on the edge of a panel (F, G, H) is an opening that is finished with a **fixed** aluminium profile with a black brush. A cable feedthrough at the front of a panel (E) is an opening that is finished with a **removable** aluminium profile with a black brush.

Auf der Bestellung ist ebenfalls anzugeben, ob die Kabelöffnung mehr links oder rechts beziehungsweise eher unten oder oben angebracht werden soll. Die exakte Lage bestimmt Pastoe dann anhand eines logischen Rasters. Die Kabelöffnung misst standardmäßig 18 cm, außer bei Paneelgrößen von 18 und 27 cm, hier ist die Kabelöffnung auf 6 cm bemessen. Eine Kabelöffnung am Rand eines Paneels (A, B, C) ist eine Aussparung **ohne** Aluminiumprofil und schwarzen Borsten. Eine Kabelöffnung am Rand eines Paneels (F, G, H) ist eine Aussparung, die mit einem **feststehenden** Aluminiumprofil und schwarzen Borsten verkleidet wird. Eine Kabelöffnung an der Vorderseite eines Paneels (E) ist eine Aussparung, die mit einem **abnehmbaren** Aluminiumprofil und schwarzen Borsten verkleidet wird.

Een kabeldoorvoer kan alleen besteld worden i.c.m. met een deur of klep. Bij bestelling wordt het achterpaneel standaard voorzien van een uitsparing tbv kabel en ontluftung. Een kabeldoorvoer aan de rand van een paneel (A, B, C, D) is een uitsparing **zonder** aluminium profiel en zwarte borstel. Een kabeldoorvoer aan de rand van een paneel (F, G, H, I) is een uitsparing afgewerkt met een **afneembaar** aluminium profiel met zwarte borstel. De kabeldoorvoer zal altijd in het midden van een vak geplaatst worden. De afmeting van de kabeldoorvoer is standaard 18cm, alleen bij een paneel van 18 en 27cm is de kabeldoorvoer 6cm.

Un passe-câbles est toujours combiné avec une porte ou un abattant. Le panneau arrière comporte en standard une encoche centrale pour faire passer le câble et pour l'aération. Un passe-câbles placé sur le côté d'un panneau (A, B, C, D) est une encoche **sans** un profilé en aluminium fixe et une brosse noire. Un passe-câbles placé sur le côté d'un panneau (F, G, H, I) est une encoche comportant un profilé en aluminium **détachable** avec une brosse noire. Le passe-câbles est toujours placé au milieu d'une section. La dimension standard du passe-câbles est de 18 cm ; seulement avec les panneaux de 18 et 27 cm, le passe-câbles est de 6 cm.

Il passacavo può essere ordinato solo insieme ad un'anta o ribalta. Il pannello posteriore è fornito di serie completo di tacca per il cavo e per l'aerazione. Un passacavo al margine di un pannello (A, B, C, D) corrisponde ad una tacca rifinita **senza** un profilo di alluminio e spazzola nera. Un passacavo al margine di un pannello (F, G, H, I) corrisponde ad una tacca rifinita con un profilo di alluminio **amovibile**, dotato di spazzola nera. Il passacavo viene sempre previsto al centro di uno scomparto. La misura del passacavo è standard ed è pari a 18 cm; solo ai pannelli di 18 e 27 cm si applica un passacavo di 6 cm.

A cable feedthrough can only be ordered in combination with a door or a flap. Upon ordering, the back panel will be fitted as standard with an opening for cable feedthrough and ventilation purposes. A cable feedthrough on the edge of a panel (A, B, C, D) is an opening **without** an aluminium profile and black brush. A cable feedthrough on the edge of a panel (F, G, H, I) is an opening that is finished with a **removable** aluminium profile with a black brush. The cable feedthrough will always be placed in the centre of a section. The width of the cable feedthrough is 18cm as standard, except for an 18 or 27cm panel, when the cable feedthrough is 6cm wide.

Eine Kabelöffnung kann ausschließlich zusammen mit einer Türe oder Klappe bestellt werden. Bei der Bestellung wird das Rückwandpaneel standardmäßig mit einer Aussparung für Kabel und Entlüftung versehen. Eine Kabelöffnung am Rand eines Paneels (A, B, C, D) ist eine Aussparung **ohne** Aluminiumprofil und schwarzen Borsten. Eine Kabelöffnung am Rand eines Paneels (F, G, H, I) ist eine Aussparung, die mit einem **abnehmbaren** Aluminiumprofil und schwarzen Borsten verkleidet wird. Die Kabelöffnung wird grundsätzlich in der Mitte eines Fachs angebracht. Die Kabelöffnung misst standardmäßig 18 cm, außer bei Paneelgrößen von 18 und 27 cm, hier ist die Kabelöffnung auf 6 cm bemessen.

